

### Overview

- 2MP (1920\*1080)
- WDR 52dB
- 2.8mm Lens
- H.265
- IR, IP67







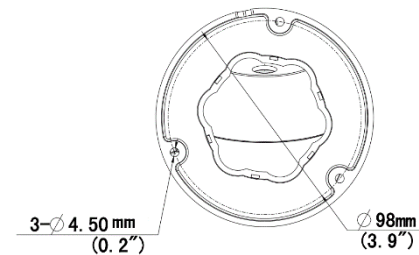
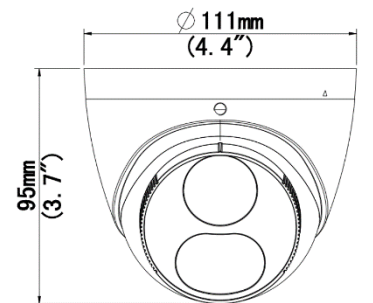

### Technical Specifications

Device	
Image Sensor:	1 / 2.8" Progressive Scan CMOS
Min Illumination:	Color: 0.01Lux (F2.0, AGC ON)   0Lux with IR
Shutter Time:	Auto/Manual, 1 ~ 1/100000s
Lens:	2.8mm@F2.0
WDR:	52 dB
Angle of View:	H: 106.7°, V: 57.1°, O: 115.7°
Angle Adjustment:	Pan: 0° ~ 360°   Tilt: 0° ~ 80°   Rotate: 0° ~ 360°
3-Axis Adjustment:	Yes
Day & Night:	IR-Cut Filter with Auto Switch (ICR)
IR Range:	Up to 30m (98ft) IR range
Compression Standard	
Video Compression:	H.265, H.264
Video Bit Rate:	128 Kbps ~ 6 Mbps
Two Stream:	Yes
Analytics:	Motion Detection
Image	
Max. Image Resolution:	1920 x 1080
Frame Rate:	30fps (1920 x 1080)
ROI Codec:	Up to 8 areas
Image Setting:	White Balance, Digital Noise Reduction, Smart IR, Flip, HLC, BLC



## Technical Specifications

Network	
Protocols:	IPv4, IGMP, ICMP, TCP, UDP, DHCP, RTP, RTSP, RTCP, DNS, DDNS, NTP, UPnP, HTTP
Interface	
Communication Interface:	10M/100M Base-TX Ethernet
General	
Safety	CE, IEC62368-1
EMC	FCC Part 15, EN 55032:2015+A11:2020, EN 55035: 2017+A11:2020
Operating Conditions:	Temperature: -30°C~60°C (-22°F~140°F), Humidity: ≤95% RH (Non-Condensing)
Power Consumption:	Max 5.0 W
Power Supply:	DC 12V±25%, PoE (IEEE 802.3af)
Weatherproof Rating:	IP67
Dimensions:	Φ111 x 95mm (Φ4.4" x 3.8")
Net Weight:	0.29kg (0.64lb)
Software:	No license required for use with Video Insight Software
Accessories	<div style="display: flex; flex-wrap: wrap; justify-content: space-around;"> <div style="text-align: center;"> <p>M-JB-T2</p>  </div> <div style="text-align: center;"> <p>M-WM-JB-MINI</p>  </div> <div style="text-align: center;"> <p>M-WM-MINI</p>  </div> <div style="text-align: center;"> <p>M-PM</p>  </div> <div style="text-align: center;"> <p>M-NPT34</p>  </div> <div style="text-align: center;"> <p>M-Pendant-Ex</p>  </div> </div>